

REMOTE GREASE LINES

& auto lube fittings

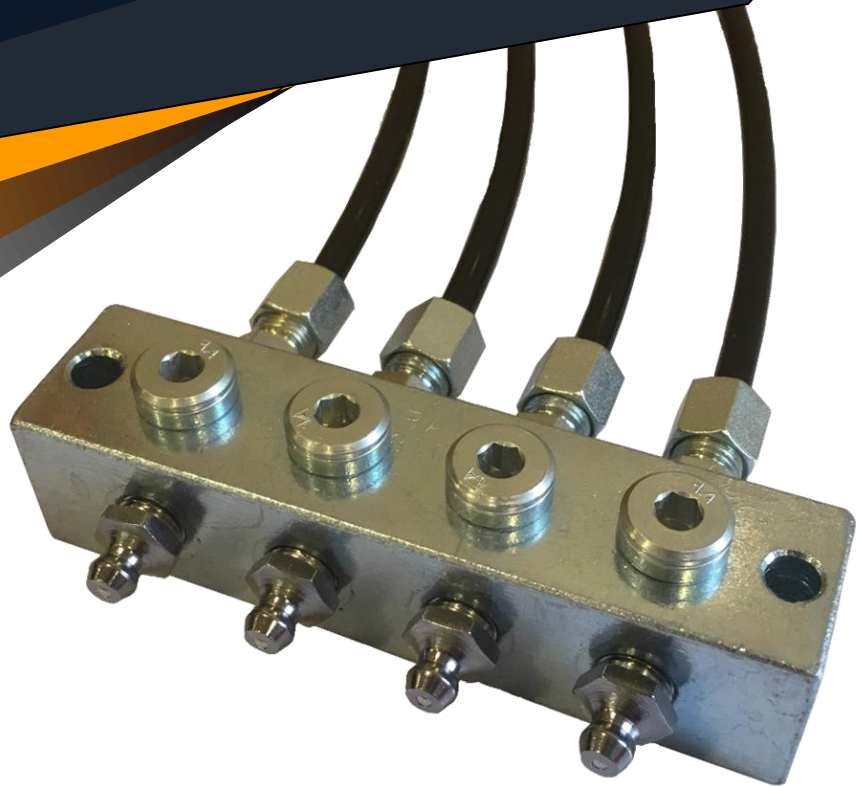

WELCOME

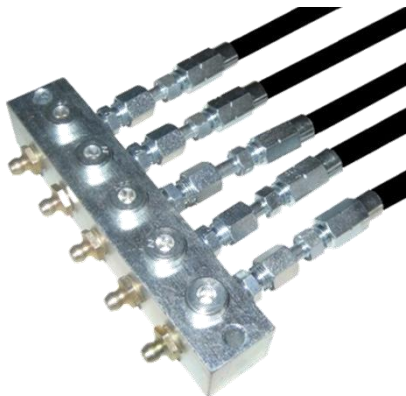

Lubrication is the life blood of any machine. This is why greasing your machinery regularly is of utmost importance.

Whether you are driving a truck, tractor, ship or you are maintaining a fixed plant you need to make it easy, safe and efficient to grease those moving parts.

With the extensive **Fat Adder** Remote Grease Line range it is possible to grease those hard to reach, dangerous or contaminated grease points and in most cases whilst the machine is running.

Even in the harshest conditions **Fat Adder** Remote Grease Lines can meet your greasing needs. Irrespective of dust, salt water, vibration or direct sunlight **Fat Adder** Remote Grease Lines can be installed to your chosen lubrication point. Simply mount a Bulkhead, Grease Anchor Block, or Divider Valve, then install one of our high pressure fitting and tube options to your existing grease nipple. You will then have a reliable and safe grease system that will last for years to come.

The **Fat Adder** Remote Grease Line systems can be customised to your application:

- 6mm nylon tube and compression fitting system
- 6mm nylon tube and push-in fitting system
- 6mm, 8mm, 10mm stainless tube and compression fitting system
- 8.6mm high pressure tube with field adaptable reusable fitting system
- 8.6mm high pressure tube with field adaptable 7/16 JIC fitting system
- 11.3mm high pressure tube with field adaptable reusable fitting system

The **Fat Adder** Remote Grease Lines range is manufactured to the highest quality standards and can also be used in conjunction with conventional automatic grease lubrication systems!



SYSTEM OPTIONS

6mm Nylon Tube with Compression Fitting

6mm nylon tube and compression fittings features:

- Rated to 1,291PSI (89 Bar, 8.9MPa)
- Budget and cost effective
- 6mm olive within the compression fitting clamps around 6mm tube once tightened seals system
- Tube lengths up to 5m can be achieved
- Ideal for mild to moderate environments
- Fittings are also available in stainless steel

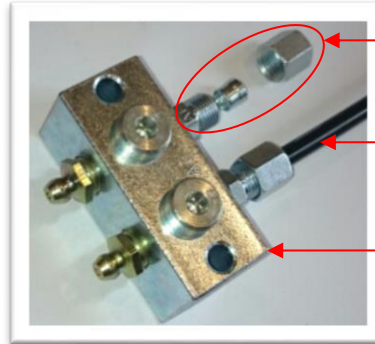

99-SCF1/8BSP: 1/8BSP x 6mm tube compression fitting before assembly (nut & olive)

99-PT25M: 6mm nylon tube complete compression fitting

99-RGB2: 2 outlet grease anchor block with grease nipples. T drilled giving the option to install grease lines at 90deg

6mm Nylon Tube with Push-In Fittings

6mm nylon tube and push-in fittings features:

- Rated to 1,291PSI (89 Bar, 8.9MPa)
- Quick installation
- Quick disconnect if required
- 90 deg swivel fittings are available making installation in tight spaces easy
- Tube lengths up to 5m can be achieved
- Ideal for mild to moderate environments

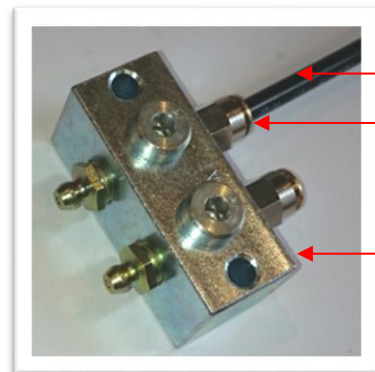

99-PT25M: 6mm nylon tube

99-PISC1/8BSP: 6mm push in fitting

99-RGB2: 2 outlet grease anchor block with grease nipples. T drilled giving the option to install grease lines at 90deg

6mm, 8mm and 10mm Stainless Rigid Tube

6mm, 8mm and 10mm stainless ridged tube features

- Rated to 5,438PSI (374Bar, 37.4MPa)
- Tube lengths up to 15m can be achieved with 10mm
- Ideal for extreme environments (ie corrosive)
- Can be used with normal steel compression fittings

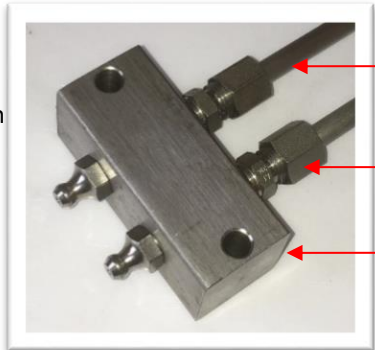

29-SS6M8MM: 8mm stainless tube

99-SCF1/8BSPSS: Stainless compression fitting

99-RGB2SS Stainless 2 outlet grease anchor block with Stainless grease nipples. "Not T-drilled"

8.6mm and 11.3mm High Pressure Tube with Field Adaptable Reusable Fittings

8.6mm and 11.3mm high pressure tube with fittings

- Rated to 12,184PSI (840 Bar, 84MPa)
- Field adaptable and easy installation
- Extreme high pressure
- Tube lengths up to 18m (11.3mm)
- Ideal for extreme environments
- 8.6mm fittings available in stainless

Note: 11.3mm is only available with compression fitting, hose tail and screw Sleeve (1). Not available in JIC or Swivel.

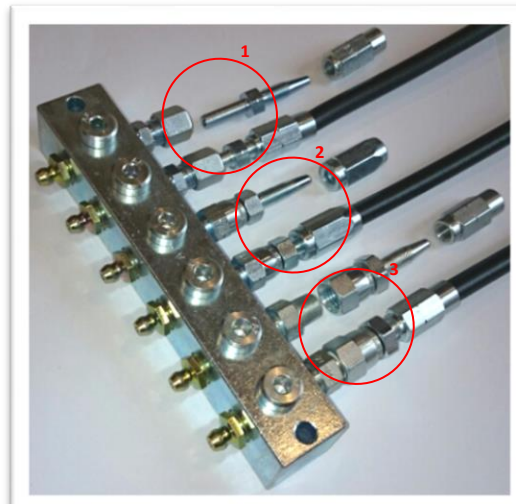

1. Reusable hose stud fitting:
 - compression fitting (99-SCF1/8BSP)
 - hose tail (99-HSS20M) and
 - screw sleeve (99-SS)

2. Reusable swivel fitting:
 - Swivel hose stud (99-RHESWSSBSP)
 - Screw Sleeve 99-RHESS

3. Reusable fitting 7-1/16 JIC fittings:
 - 1/8BSP to JIC Nipple (41-JICNIP1/8BSP)
 - JIC hose tail (41-JIC908.6)
 - Screw Sleeve (99-SS)

GREASE ANCHOR BLOCKS

Use grease bulk heads and/or anchor blocks to mount grease nipples securely and remotely. Then choose fittings and tube (pages 3,4,5).

Remote Grease Bulk Head



94-BH1/8BSP	Bulkhead (nickel plated) 1/8BSP female thread Length: 9mm, Ø 16mm. 1/8BSP grease nipple included
99-BH6M	Bulkhead 6mm tube compression fitting Length: 25mm, Ø 12mm 1/8BSP grease nipple included
99-BH6MSS	Bulkhead (stainless steel) 6mm tube compression fitting Length: 25mm, Ø 12mm 1/8BSP grease nipple included
61-BH6MMPI	Bulkhead 6mm tube Pushin fitting Length: 16mm, Ø 12mm 1/8BSP grease nipple included
99-BH4M	Bulk head 6mm tube compression fitting Length: 10mm, Ø 12mm 6mm grease nipple included
38-SOC1/8BSP	1/8 BSP Socket Steel, grease nipple included
94-SOC1/8BSPBR	Brass 1/8 BSP Socket Steel, grease nipple included
29-SOC1/8BSPSS	Stainless 1/8 BSP Socket Steel, grease nipple included

Remote Grease Anchor Block

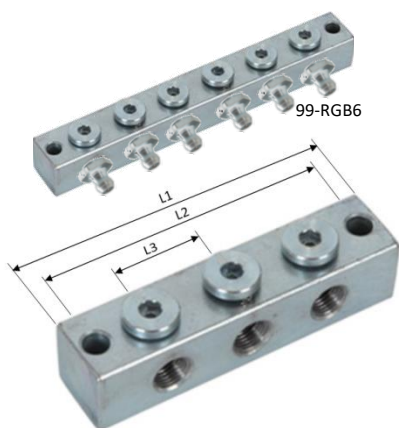

99-RGB1	1 outlet 1/8BSP grease block with grease nipple
99-RGB1SS	Stainless 1 outlet 1/8BSP grease block with grease nipples
99-RGB2	2 outlet 1/8BSP grease block with grease nipples
99-RGB2SS	Stainless 2 outlet 1/8BSP grease block with grease nipples
99-RGB3	3 outlet 1/8BSP grease block with grease nipples
99-RGB3SS	Stainless 3 outlet 1/8BSP grease block with grease nipples
99-RGB4	4 outlet 1/8BSP grease block with grease nipples
99-RGB4SS	Stainless 4 outlet 1/8BSP grease block with grease nipples
99-RGB5	5 outlet 1/8BSP grease block with grease nipples
99-RGB5SS	Stainless 5 outlet 1/8BSP grease block with grease nipples
99-RGB6	6 outlet 1/8BSP grease block with grease nipples
99-RGB6SS	Stainless 6 outlet 1/8BSP grease block with grease nipples
99-RGB8	8 outlet 1/8BSP grease block with grease nipples
99-RGB8SS	Stainless 8 outlet 1/8BSP grease block with grease nipples

	L1 (mm)	L2 (mm)	L3 (mm)
99-RGB1	38	28	-
99-RGB2	60	50	22
99-RGB3	80	74	22
99-RGB4	106	96	22
99-RGB5	128	118	22
99-RGB6	150	140	22
99-RGB8	194	184	22

NOTES:

Steel block are T-drilled giving the option to install the grease line in line with the grease nipple or 90 degrees to the grease nipple. 1/8BSP plugs are included.
Stainless steel block only drilled straight through. Not T-drilled.

IMPORTANT:

Never split or Tee grease lines. Grease will take the path of least resistance, starving the other lubrication points. If you need to spit grease lines – use a grease divider valve (see page 8)



99-RGB3 with 6mm nylon tube & compression fittings installed at 90 deg



99-RGB2 with 10mm stainless tube & compression fittings

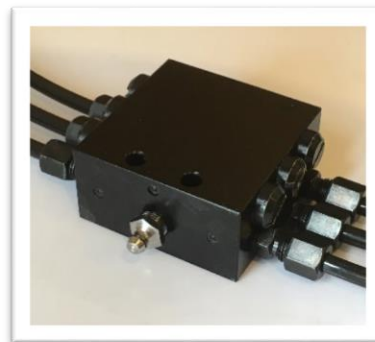

100-DDV6 Divider Valve (see page 8) with 6mm nylon tube & compression fittings

6MM NYLON TUBE SYSTEMS

6mm Nylon Tube - Semi Rigid 1,291PSI / 9MPa / 89 BAR Operating Pressure – Bending Radius Approx. 40mm

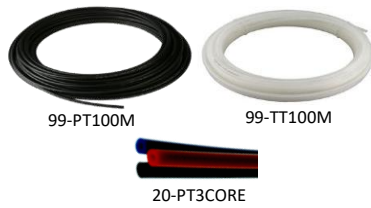

99-PT25MGF	25m x 6mm high pressure tube - grease filled (NLGI 2)
99-PT100MGF	100m x 6mm high pressure tube - grease filled (NLGI 0)
99-PT25M	25m x 6mm high pressure tube - empty
99-PT100M	100m x 6mm high pressure tube - empty
99-TT10M	10m x 6mm high pressure transparent tube – empty
99-TT100M	100m x 6mm high pressure transparent tube – empty
20-PT2COREGF1M	1m x 6mm 2 core grease line – grease filled (filled NLGI 2) – up to 25m
20-PT3COREGF1M	1m x 6mm 3 core grease line – grease filled (filled NLGI 2) – up to 25m

Straight Compression Fitting - 6mm Tube



99-SCF6M	Straight M6 x 6mm tube comp fitting
99-SCF6MSS	Stainless Straight M6 x 6mm tube comp fitting
99-SCF8M	Straight M8 x 6mm tube comp fitting
99-SCF8MSS	Stainless Straight M8 x 6mm tube comp fitting
99-SCF1/8BSP	Straight 1/8BSP x 6mm tube comp fitting
99-SCF1/8BSPSS	Stainless Straight 1/8BSP x 6mm tube comp fitting
99-SCF1/4BSP	Straight 1/4BSP x 6mm tube comp fitting
99-SCF1/8NPT	Straight 1/8NPT x 6mm tube comp fitting
20-SCFF1/8BSP	Straight 1/8BSP Female x 6mm tube comp fitting
99-C6M	6mm x 6mm Straight comp fitting connector
99-C6MSS	Stainless 6mm x 6mm Straight comp fitting connector

90 Degree Compression Fitting – 6mm Tube



99-CF906M	90 deg M6 x 6mm tube comp fitting
99-CF906MSS	Stainless 90 deg M6 x 6mm tube comp fitting
99-CF908M	90 deg M8 x 6mm tube comp fitting
99-CF908MSS	Stainless 90 deg M8 x 6mm tube comp fitting
99-CF901/8BSP	90 deg 1/8BSP x 6mm tube comp fitting
99-CF901/8BSPSS	Stainless 90 deg 1/8BSP x 6mm tube comp fitting
99-CF901/8NPT	90 deg 1/8NPT x 6mm tube comp fitting

Nuts & Olives – 6mm Tube

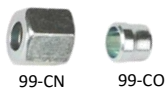

99-CN	6mm nut
99-CO	6mm olive
99-CNSS	Stainless 6mm nut
99-COSS	Stainless 6mm olive

Push-in Straight – 6mm Tube



99-PISC6M	Straight M6 x 6mm tube push in fitting
99-PISC8M	Straight M8 x 6mm tube push in fitting
99-PISC10M	Straight M10 x 6mm tube push in fitting
99-PISC1/8BSP	Straight 1/8BSP x 6mm tube push in fitting
99-PISC1/8NPT	Straight 1/8NPT x 6mm tube push in fitting
99-PISC1/4UNF	Straight 1/4UNF x 6mm tube push in fitting
99-PIC6M	6mm x 6mm Straight push in fitting connector

Push-in Elbow (Fixed) – 6mm Tube



99-PIEC906M	90 deg M6 x 6mm tube push in fitting
99-PIEC908M	90 deg M8 x 6mm tube push in fitting
99-PIEC9010M	90 deg M10 x 6mm tube push in fitting
99-PIEC901/8	90 deg 1/8BSP x 6mm tube push in fitting
99-PIEC901/4UNF	90 deg 1/4UNF x 6mm tube push in fitting

Push-in Elbow (Swivel) - 6mm Tube



99-PISWC906M	90 deg swivel M6 x 6mm tube push in fitting
99-PISWC908M	90 deg swivel M8 x 6mm tube push in fitting
99-PISWC9010M	90 deg swivel M10 x 6mm tube push in fitting
99-PISWC901/8	90 deg swivel 1/8BSP x 6mm tube push in fitting
99-PISWC901/8NPT	90 deg swivel 1/8NPT x 6mm tube push in fitting
99-PISWC901/4UNF	90 deg swivel 1/4UNF x 6mm tube push in fitting

8.6MM EXTREME HIGH PRESSURE TUBE

Note: 6mm Compression fittings need to be used with hose studs or 6mm pushin fittings can be used with groove hose studs.

Extreme High Pressure Tube 8.6mm (8.6mm OD)



99-HPH50MGF	50m x 8.6mm grease filled high pressure tube/m
99-HPH50M	50m x 8.6mm high pressure tube - empty/m
99-HPH10MGF	10m x 8.6mm grease filled high pressure tube/m
99-HPH10M	10m x 8.6mm high pressure tube - empty/m

Hose Stud 6mm Stem – To Be Used with 6mm Compression Fittings (See page 4) – 8.6mm Tube



99-HS456M24	45 deg x 6mm hose stud (24mm x 15mm)
99-HS456M35	45 deg x 6mm hose stud (35mm x 25mm)
99-HS456MSS	Stainless 45 deg x 6mm hose stud (35mm x 25mm)
99-HS906M21	90 deg x 6mm hose stud (13mm x 21mm)
99-HS906M29	90 deg x 6mm hose stud (17mm x 29mm)
99-HS906M37	90 deg x 6mm hose stud (28mm x 37mm)
99-HS906M53	90 deg x 6mm hose stud (28mm x 53mm)
99-HS906MSS	Stainless 90 deg x 6mm hose stud (28mm x 37mm)
99-HSS20M	Straight 6mm hose stud (20mm)
99-HSS30M	Straight 6mm hose stud (30mm)
99-HSS30MSS	Stainless Straight 6mm hose stud (30mm)
99-HSS65M	Straight 6mm hose stud (65.5mm)
99-HSS08M	Straight 8.6mm x 8.6mm hose stud connector/joiner
99-HSSC6M	Straight 8.6mm hose stud x 6mm compression fitting

6mm Hose Stud with Groove – To Be Used with Push-In Fittings (See page 4)- 8.6mm Tube



99-HSGR456M	45 deg x 6mm hose stud with groove (24mm x 15mm)
99-HS906GRM17	90 deg x 6mm hose stud with groove (28 x 37)
99-HSSGR20M	Straight 6mm hose stud with groove(20mm)

Screw Sleeve – Use with Hose Stud – 8.6mm Tube



99-SS	Screw sleeve
99-SSSS	Stainless screw sleeve

Reusable Hose End Swivel & Hose Stud – 8.6mm Tube



99-RHESWSSNPT	Reusable hose end stud 1/8NPT, swivel with screw sleeve
99-RHESONPT	Reusable hose end stud 1/8NPT only
99-RHESWSSBSP	Reusable hose end stud 1/8BSP, swivel with screw sleeve
99-RHESOBSP	Reusable hose end stud 1/8BSP only
99-RHESS	Screw Sleeve for reusable hose end only

7/16 JIC Reusable Hose Stud



41-JIC8.6COM	Straight 7/16 JIC reusable hose end 8.6mm hose complete
41-JIC8.6	Straight 7/16 JIC reusable hose end for 8.6mm hose
41-JIC8.6COMSS	Stainless Straight 7/16 JIC reusable hose end 8.6mm hose complete
41-JIC8.6SS	Stainless straight 7/16 JIC reusable hose end for 8.6mm hose
41-JIC908.6COM	90 deg 7/16 JIC reusable hose end 8.6mm hose complete
41-JIC908.6	90 deg 7/16 JIC reusable hose end for 8.6mm hose
41-JIC908.6SS	Stainless 90 deg 7/16 JIC Reusable hose end for 8.6mm hose
41-JIC908.6COMSS	Stainless 90 deg 7/16 JIC Reusable hose end 8.6mm hose complete
41-JIC458.6COM	45 deg 7/16 JIC Reusable hose end 8.6mm hose complete
41-JIC458.6	45 deg 7/16 JIC Reusable hose end for 8.6mm hose
99-SS	Screw sleeve
99-SSSS	Stainless screw sleeve
41- JICNIP1/8BSP	7/16" Male x 1/8BSP male nipple straight
41- JICNIP1/8BSPSS	Stainless 7/16" male x 1/8BSP male nipple straight
41-JICNIP8MM	7/16" male x 8mm male nipple straight
41-JICNIP6MM	7/16" male x 6mm male nipple straight
97-JICJIC	7/16" male x 7/16" male nipple straight joiner
94-JICJICSS	Stainless 7/16" male x 7/16" male nipple straight joiner

11.3MM EXTREME HIGH PRESSURE TUBE

Note: Compression fittings need to be used with 11.3mm hose studs

11.3mm High Pressure Tube



99-EHP100M	100m x 11.3mm high pressure tube - empty
99-EHP100MGF	100m x 11.3mm grease filled high pressure tube

Screw Sleeve – 11.3mm



99-SS11	Screw sleeve 11.3mm hose
99-SS11SS	Stainless Screw Sleeve 11.3mm hose

Hose Studs – 11.3mm



99-HS11S6M	Straight hose stud 6mm for 11.3mm hose (20mm)
99-HS11456M	45 deg hose stud 6mm for 11.3mm hose (22mm x 45mm)
99-HS11906M	90 deg hose stud 6mm for 11.3mm hose (22mm x 45mm)
99-HS11S820M	Straight hose stud 8mm for 11.3mm hose (20mm)
99-HS11S820MSS	Stainless straight hose stud 8mm for 11.3mm hose (20mm)
99-HS11458M	45 deg hose stud 8mm for 11.3mm hose (22mm x 45mm)
99-HS11908M	90 deg hose stud 8mm for 11.3mm hose (22mm x 36mm)
99-HS11908MSS	Stainless 90 deg hose stud 8mm for 11.3mm hose (22mm x 36mm)
99-HS11S10M	Straight hose stud 10mm for 11.3mm hose (30mm)
99-HS119010M	90 deg hose stud 10mm for 11.3mm hose (23mm x 36mm)

Straight Compression Fittings – To Be Used with 11.3mm Hose Studs (and 6mm, 8mm, 10mm Stainless Rigid Tube – See Page 8)



99-SCF101/4



99-C10M

99-SCF6M	Straight M6 x 6mm tube comp fitting
99-SCF6MSS	Stainless Straight M6 x 6mm tube comp fitting
99-SCF8M	Straight M8 x 6mm tube comp fitting
99-SCF8MSS	Stainless Straight M8 x 6mm tube comp fitting
99-SCF10M	Straight M10 x 6mm tube comp fitting
99-SCF1/8	Straight 1/8BSP x 6mm tube comp fitting
99-SCF1/8SS	Stainless Straight 1/8BSP x 6mm tube comp fitting
99-SCF1/4	Straight 1/4BSP x 6mm tube comp fitting
99-SCF1/4SS	Stainless Straight 1/4BSP x 6mm tube comp fitting
99-SCF1/8NPT	Straight 1/8NPT x 6mm tube comp fitting
99-SCF086M	Straight M6 x 8mm tube comp fitting
99-SCF088M	Straight M8 x 8mm tube comp fitting
99-SCF081/8	Straight 1/8BSP x 8mm tube comp fitting
99-SCF081/8	Stainless Straight 1/8BSP x 8mm tube comp fitting
99-SCF081/4	Straight 1/4BSP x 8mm tube comp fitting
99-SCF081/4SS	Stainless Straight 1/4BSP x 8mm tube comp fitting
99-SCF101/8	Straight 1/8BSP x 10mm tube comp fitting
99-SCF101/4	Straight 1/4BSP x 10mm tube comp fitting
99-C6M	6mm x 6mm Straight comp fitting connector
99-C8M	8mm x 8mm Straight comp fitting connector
99-C10M	10mm x 10mm Straight comp fitting connector
99-C610M	6mm x 10mm Straight comp fitting connector

90 Degree Compression Fitting - 11.3mm Hose Studs (and 6mm, 8mm, 10mm stainless ridged tube)



99-CF906M	90 deg M6 x 6mm tube comp fitting
99-CF906MSS	Stainless 90 deg M6 x 6mm tube comp fitting
99-CF908M	90 deg M8 x 6mm tube comp fitting
99-CF9010M	90 deg M10 x 6mm tube comp fitting
99-CF908MSS	Stainless 90 deg M8 x 6mm tube comp fitting
99-CF901/8	90 deg 1/8BSP x 6mm tube comp fitting
99-CF901/8SS	Stainless 90 deg 1/8BSP x 6mm tube comp fitting
99-CF901/4BSP	90 deg 1/4BSP x 6mm tube comp fitting
99-CF901/4BSPSS	Stainless 90 deg 1/4BSP x 6mm tube comp fitting
99-CF901/8NPT	90 deg 1/8NPT x 6mm tube comp fitting
99-CF90881/4BSPSS	Stainless 90 deg 1/4BSP x 8mm tube comp fitting
99-CF90101/4	90 deg 1/4BSP x 10mm tube comp fitting

ADAPTORS & REDUCERS

Straight Adaptors 1/8BSP Female (All Metric Male Threads Are 1.5 Unless Otherwise Specified)



99-ATM8X18BSP



94-ATM14X18BSPBR

94-ATM5X18BSPB	Brass straight adaptor M5/0.8 x 1/8BSP female
99-ATM6X18BSP	Straight adaptor M6/1.0 male x 1/8BSP female
94-ATM6X18BSPSS	Stainless Straight adaptor M6/1.0 male x 1/8BSP female
94-ATM8X18BSPBR	Brass Straight adaptor M8/1.0 male x 1/8BSP female
94-ATM8125X18BSPBR	Brass Straight adaptor M8/1.25 male x 1/8BSP female
99-ATM8X18BSP	Straight adaptor M8/1.0 male x 1/8BSP female
94-ATM10X18BSPBR	Brass Straight adaptor M10/1.5 male x 1/8BSP female
94-ATM12X18BSPBR	Brass Straight adaptor M12/1.5 male x 1/8BSP female
94-ATM14X18BSPBR	Brass Straight adaptor M14/1.5 male x 1/8BSP female
94-ATM16X18BSPBR	Brass Straight adaptor M16/1.5 male x 1/8BSP female
99-A14X18S20	Straight adaptor 1/4BSP Male x 1/8BSP female – 20mm
98-AT14UNEFX18	Straight adaptor 1/4UNEF Male x 1/8BSP female
99-ATUNFX18	Straight adaptor 1/4UNF Male x 1/8BSP female
99-AT14BSFX18	Straight adaptor 1/4BSF Male x 1/8BSP female
94-AT1/8NPT18BR	Brass Straight adaptor 1/8NPT Male x 1/8BSP female

Straight Extensions 1/8BSP Male x 1/8BSP Female (Extension Is Measured On Overall Length – Threaded Part = 10mm Approx.)



99-AT18X18BSP35

98-AT18X18BSP85

99-AT18X18BSP18	Straight extension 1/8BSP male x 1/8BSP female - 18mm
99-AT18X18BSP18SS	Stainless straight extension 1/8BSP Male x 1/8BSP female -18mm
99-AT18X18BSP23	Straight extension 1/8BSP male x 1/8BSP female – 23mm
99-AT18X18BSP23SS	Stainless straight extension 1/8BSP male x 1/8BSP female –23mm
99-AT18X18BSP35	Straight extension 1/8BSP male x 1/8BSP female – 35mm
99-AT18X18BSP35SS	Stainless straight extension 1/8BSP male x 1/8BSP female –35mm
99-AT18X18BSP45	Straight extension 1/8BSP male x 1/8BSP female – 45mm
99-AT18X18BSP50	Straight extension 1/8BSP male x 1/8BSP female – 50mm
99-AT18X18BSP50SS	Stainless straight extension 1/8BSP male x 1/8BSP female –50mm
98-AT18X18BSP85	Straight extension 1/8BSP male x 1/8BSP female – 85mm
98-AT18X18BSP100	Straight extension 1/8BSP male x 1/8BSP female – 100mm
98-AT18X18BSP187	Straight extension 1/8BSP male x 1/8BSP female – 187mm

Straight Adaptors & Extensions 1/4BSP Female



94-ATM12X14BSPBR

94-ATM6X14BSPBR	Brass straight adaptor 6mm male x 1/4BSP female
58-ATM6X14BSPSS	Stainless straight adaptor 6mm male x 1/4BSP female
94-ATUNFX14BR	Brass straight adaptor 1/4UNF male x 1/4BSP female
94-ATUNFX14SS	Stainless straight adaptor 1/4UNF male x 1/4BSP female
94-ATM8X14BSPBR	Brass straight adaptor 8mm male x 1/4BSP female
99-ATM8X14BSP	Straight adaptor 8mm male x 1/4BSP female
99-AT14X14BSP85	Straight extension 1/4BSP male x 1/4BSP Female – 85mm
99-AT14X14BSP104	Straight extension 1/4BSP male x 1/4BSP Female – 104mm
94-ATM10X14BSPBR	Brass Straight adaptor 10mm(1.5) male x 1/4BSP female
94-ATM12X14BSPBR	Brass Straight adaptor 12mm(1.5) male x 1/4BSP female

45 Degree & 90 Degree Elbow Adaptors



99-A451/8BSP



99-A901/8BSP

99-A451/8BSP	45 deg adaptor 1/8BSP male x 1/8BSP female
99-451/8BSPSS	Stainless 45 adaptor 1/8BSP male x 1/8BSP female
99-A45M6X18BSP	45 deg adaptor 6mm male x 1/8BSP female
99-A901/8BSP	90 deg adaptor 1/8BSPM x 1/8BSP female
99-A901/8BSPSS	Stainless 90 deg adaptor 1/8BSPM x 1/8BSP female
20-A901/4UNFX18BSP	90 deg adaptor 1/4UNFM male / 1/8 BSP female
98-A90M6X18BSP	90 deg adaptor 6mm male x 1/8BSP female
99-A90M8X18BSP	90 deg adaptor 8mm male x 1/8 BSP female
41-A90T14BSFX18BSP	90 deg adaptor 1/4BSF male x 1/8BSP female

ADDITIONAL PARTS

Note: Steel tube needs to be used with compression fittings – see page 6

Stainless Tube (Empty) – 1mm wall 5,424PSI / 37MPA / 374 Bar Operating Pressure



29-SS6M6MM	Stainless 6m x 6mm x 1mm wall tube
29-SS6M8MM	Stainless 6m x 8mm x 1mm wall tube
29-SS6M10MM	Stainless 6m x 10mm x 1mm wall tube

10mm Heavy Wall Tube (empty) – 3.5mm Wall



20-HWST065M10MM	Steel tube 650mm x 10mm x 1/8BSP x 3.5mm wall 1/8BSP end
20-HWST080M10MM	Steel tube 800mm x 10mm x 1/8BSP 3.5mm wall 1/8BSP end
20-HWST170M10MM	Steel tube 1750mm x 10mm x 1/8BSP 3.5mm 1/8BSP end
20-HWST190M10MM	Steel tube 1900mm x 10mm x 3.5mm wall 1/8BSP end

Grease Divider Valves – Divides Grease Evenly Amongst All Outlets – (For Working Principle See www.remotegreaselines.com)



100-DDV6	6 outlet divider valve with 6 x 6mm tube check comp fittings
100-DDV8	8 outlet divider valve with 8 x 6mm tube check comp fittings
100-DDV10	10 outlet divider valve with 10 x 6mm tube check comp fittings
100-DDV12	12 outlet divider valve with 12 x 6mm tube check comp fittings

Grease Divider Valve Check Valve Fitting



41-6MMCVFPU

99-CV6M18BSP

99-CFNV6MBL	Check valve straight M10 male x 6mm tube comp fitting (suit DDV and SSV valves)
41-6MMCVFPU	Check valve straight M10 male x 6mm tube pushin fitting (suit DDV and SSV valves)
99-CV6M18BSP	Check valve straight 1/8BSP x 6mm comp fitting

1/8BSP Plug



99-PLUG1/8	Closure plug 1/8BSP
------------	---------------------

Rotating, Swivel And Banjo Fittings



99-SU1/8M



41-RU15001/8

99-BF1/8



99-BF1/8	Banjo fitting 1/8BSP male x 6mm tube
99-SU1/8M	Swivel Union 1/8BSP male x 1/8BSP female
73-RU5001/8	500RPM Rotary union connector 1/8BSP
73-RU5001/4	500RPM Rotary union connector 1/4BSP
41-RU15001/8	1500RPM Rotary union connector 1/8BSP

Bulkheads



99-BH6MMPI



94-BH1/8BSP



99-BH4M



99-BH6M



99-BHS6M6M



99-BE906M

94-BH1/8BSP	Bulkhead (nickel plated) 1/8BSP female thread Length: 9mm, Ø 16mm. 1/8BSP grease nipple included
99-BH6M	Bulkhead 6mm tube compression fitting Length: 25mm, Ø 12mm 1/8BSP grease nipple included
99-BH6MSS	Bulkhead (stainless steel) 6mm tube compression fitting Length: 25mm, Ø 12mm 1/8BSP grease nipple included
61-BH6MMPI	Bulkhead 6mm tube Pushin fitting Length: 16mm, Ø 12mm 1/8BSP grease nipple included
99-BH4M	Bulk head 6mm tube compression fitting Length: 10mm, Ø 12mm 6mm grease nipple included
99-BHS6M6M	Bulkhead straight 6mm tube x 6mm tube
99-BHS8M8M	Bulkhead straight 8mm tube x 8mm tube
99-BE906M	90 deg bulkhead 6mm tube x 6mm tube
99-BE906MSS	Stainless 90 deg bulkhead 6mm tube x 6mm tube
99-BE908M	90 deg bulkhead 8mm tube x 8mm tube
99-BE908MSS	Stainless 90 deg bulkhead 8mm tube x 8mm tube

MORE ADDITIONAL PARTS

P-Clamps



99-PCLAMP6MM	P-Clamp 6mm (5mm mounting hole)
99-PCLAMP9MM	P-Clamp 9mm (5mm mounting hole)
99-PCLAMP16MM	P-Clamp 16mm (5mm mounting hole)
99-PCLAMP19MM	P-Clamp 19mm (5mm mounting hole)
94-PCLAMP6MMSS	Stainless P-Clamp 6mm (5mm mounting hole)
94-PCLAMP10MMSS	Stainless P-Clamp 10mm (5mm mounting hole)
94-PCLAMP16MMSS	Stainless P-Clamp 16mm (5mm mounting hole)
94-PCLAMP19MMSS	Stainless P-Clamp 19mm (5mm mounting hole)

Nylon Hose Clamps



29-DCLAMP10MM



29-SCLAMP10MM

29-SCLAMP6MM	Single nylon hose clamp 6mm
29-SCLAMP8MM	Single nylon hose clamp 8mm
29-SCLAMP10MM	Single nylon hose clamp 10mm
29-SCLAMP12MM	Single nylon hose clamp 12mm
29-DCLAMP6MM	Double nylon hose clamp 6mm
29-DCLAMP8MM	Double nylon hose clamp 8mm
29-DCLAMP10MM	Double nylon hose clamp 10mm
29-DCLAMP12MM	Double nylon hose clamp 12mm
29-SCLAMP6MMSS	Stainless single nylon hose clamp 6mm
29-SCLAMP8MMSS	Stainless single nylon hose clamp 8mm
29-SCLAMP10MMSS	Stainless single nylon hose clamp 10mm
29-DCLAMP6MMSS	Stainless double nylon hose clamp 6mm
29-DCLAMP8MMSS	Stainless double nylon hose clamp 8mm
29-DCLAMP10MMSS	Stainless double nylon hose clamp 10mm

Spiral Hose Guard



99-SPG925



99-SPG10SS

99-SPG625	25m x Spiral guard 6mm (suits 6mm nylon tube)
99-SPG925	25m x Spiral guard 9mm (suits the 8.6mm hose)
99-SPG10SS	Stainless 5m x spiral guard 10mm (Suits the 8.6mm hose)

Tube Cutter



94-TCHD



94-TC

94-TC	Tube Cutter – suit nylon, 8.6mm and 11.3mm tube
94-TCS	Tube Cutter – standard duty suit 6mm to 10mm stainless
94-TCHD	Tube Cutter – heavy duty

Tube Bender



94-TB6	Tube bender suit 6mm stainless
94-TB8	Tube bender suit 8mm stainless
94-TB10	Tube bender suit 10mm stainless

Grease Stickers



41-GSR10	"GREASE" sticker 80mm x 20mm - RED (lots of 10)
41-GSG10	"GREASE" sticker 80mm x 20mm - GREEN (lots of 10)

Grease Nipple Thread Tester

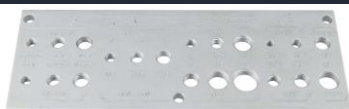

96-GFTT	Grease nipple thread tester
---------	-----------------------------

REMOTE GREASING STARTER KITS

6mm Nylon Tube Remote Grease Kit with Straight Compression Fittings



99-GKNT1- <u>XXX</u>	1 outlet kit c/w anchor block with grease nipples, 5m x 6mm tube, 2 comp fittings
99-GKNT2- <u>XXX</u>	2 outlet kit c/w anchor block with grease nipples, 10m x 6mm tube, 4 comp fittings
99-GKNT3- <u>XXX</u>	3 outlet kit c/w anchor block with grease nipples, 15m x 6mm tube, 6 comp fittings
99-GKNT4- <u>XXX</u>	4 outlet kit c/w anchor block with grease nipples, 20m x 6mm tube, 8 comp fittings
99-GKNT5- <u>XXX</u>	5 outlet kit c/w anchor block with grease nipples, 25m x 6mm tube, 10 comp fittings
99-GKNT6- <u>XXX</u>	6 outlet kit c/w anchor block with grease nipples, 25m x 6mm tube, 12 comp fittings
99-GKNT8- <u>XXX</u>	8 outlet kit c/w anchor block with grease nipples, 25m x 6mm tube, 16 comp fittings

Note: Change XXX to 6MM for 6mm, XXX to 8MM for 8mm, XXX to BSP for 1/8BSP, XXX to NPT for 1/8NPT!

8.6mm High Pressure Grease Kit with Hose Studs and Compression Fittings



99-GKNT1/H- <u>XXX</u>	1 outlet kit c/w anchor block with grease nipples, 5m x 8.6mm tube, 2 high pressure fitting assemblies
99-GKNT2/H- <u>XXX</u>	2 outlet kit c/w anchor block with grease nipples, 10m x 8.6mm tube, 4 high pressure fitting assemblies
99-GKNT3/H- <u>XXX</u>	3 outlet kit c/w anchor block with grease nipples, 15m x 8.6mm tube, 6 high pressure fitting assemblies
99-GKNT4/H- <u>XXX</u>	4 outlet kit c/w anchor block with grease nipples, 20m x 8.6mm tube, 8 high pressure fitting assemblies
99-GKNT5/H- <u>XXX</u>	5 outlet kit c/w anchor block with grease nipples, 25m x 8.6mm tube, 10 high pressure fitting assemblies
99-GKNT6/H- <u>XXX</u>	6 outlet kit c/w anchor block with grease nipples, 25m x 8.6mm tube, 12 high pressure fitting assemblies
99-GKNT8/H- <u>XXX</u>	8 outlet kit c/w anchor block with grease nipples, 25m x 8.6mm tube, 16 high pressure fitting assemblies

Note: Change XXX to 6MM for 6mm, XXX to 8MM for 8mm, XXX to BSP for 1/8BSP, XXX to NPT for 1/8NPT!

S-Cam Starter Kit



	3 POINT S-CAM STARTER KIT INCLUDES: 1 x 3 point 1/8BSP grease block c/w grease nipples 6 x Straight 1/8BSP x 6mm tube compression fittings 3 x 90 Deg Adaptor 1/8BSP Male x 1/8BSP Female 2 x Straight Adaptor M6/1 Male x 1/8BSP Female 2 x Straight Adaptor 1/4UNF Male x 1/8BSP Female 1 x Straight Extension 1/8BSP Male x 1/8BSP Female (23mm) 1 x 10m 6mm nylon tube
40-SCAM/3	
	6 POINT S-CAM STARTER KIT INCLUDES: 1 x 6 point 1/8BSP grease block c/w grease nipples 12 x Straight 1/8BSP x 6mm tube compression fittings 6 x 90 Deg Adaptor 1/8BSP Male x 1/8BSP Female 4 x Straight Adaptor M6/1 Male x 1/8BSP Female 4 x Straight Adaptor 1/4UNF Male x 1/8BSP Female 2 x Straight Extension 1/8BSP Male x 1/8BSP Female (23mm) 1 x 25m 6mm nylon tube
40-SCAM/6	

GRAB KITS

Lube System Repair Kit



40-GRAB1-F
40-GRAB1-E

LUBE SYSTEM REPAIR KIT INCLUDES:

- 1 x carry assortment case
- 10m x 8.6mm tube (40-GRAB1-F= filled 40-GRAB1-E= empty)
- 5 x 90deg M6 x 6mm comp fittings
- 5 x 90deg 1/8BSP x 6mm comp fittings
- 6 x Straight M6 x 6mm comp fittings
- 6 x Straight 1/8BSP x 6mm comp fittings
- 5 x 6mm x 6mm compression connector
- 3 x 1/4BSPM x 1/8BSPF reducer
- 5 x 45deg 1/8BSP adaptors
- 5 x 90deg 1/8BSP adaptors
- 3 x 45deg hose studs 5 x 90deg hose studs
- 10 x Straight hose studs 6 x double ended hose studs
- 20 x screw sleeves
- 10 x compression nuts
- 10 x olives
- 20 x 1/8BSP Straight grease nipples
- 1 x thread tape
- 1 x tube cutter

Push In Fitting Grab Kit



40-GRAB2

PUSHIN FITTING GRAB KIT INCLUDES:

- 1 x carry assortment case
- 10m x 6mm high pressure nylon tubing
- 10 x Straight M6 x 6mm tube push in fittings
- 5 x Straight M8 x 6mm tube push in fittings
- 10 x Straight 1/8BSP x 6mm tube push in fittings
- 5 x 90 deg M6 x 6mm tube push in fittings
- 5 x 90 deg 1/8BSP x 6mm tube push in fittings
- 10 x 90 deg swivel M6 x 6mm tube push in fittings
- 5 x 90 deg swivel M8 x 6mm tube push in fittings
- 10 x 90 deg swivel 1/8BSP x 6mm tube push in fittings
- 5 x 6mm x 6mm Straight push in fitting connectors
- 3 x Straight 1/4BSP M x 1/8BSP adaptors
- 5 x 45 deg 1/8BSPM x 1/8BSPF adaptors
- 5 x 90 deg 1/8BSPM x 1/8BSPF Adaptors
- 20 x 1/BSP Straight grease nipples
- 1 x thread tape
- 1 x tube cutter

Compression Fitting Grab Kit



40-GRAB3

COMPRESSION FITTING GRAB KIT INCLUDES:

- 1 x carry assortment case
- 10m x 6mm high pressure nylon tubing
- 10 x 90 deg M6 x 6mm tube comp fittings
- 5 x 90 deg M8 x 6mm tube comp fittings
- 10 x 90 deg 1/8BSP x 6mm tube comp fittings
- 10 x Straight M6 x 6mm tube comp fittings
- 5 x Straight M8 x 6mm tube comp fittings
- 10 x Straight 1/8BSP x 6mm tube comp fittings
- 5 x Straight 1/4BSP x 6mm tube comp fittings
- 5 x 6mm x 6mm Straight comp fitting connectors
- 5 x Straight 1/4BSP M x 1/8BSP Adaptor
- 5 x 45 deg 1/8BSPM x 1/8BSPF Adaptors
- 5 x 90 deg 1/8BSPM x 1/8BSPF adaptors
- 2 x Bulkheads 1/8BSPF x 6mm tube
- 10 x compression nuts
- 10 x olives
- 20 x 1/BSP Straight grease nipples thread tape
- 1 x tube cutter

GRAB KITS

Super Deluxe Grab Kit



40-GRAB4

SUPER DELUXE COMBO GRAB KIT INCLUDES:

- 1 x carry assortment case
- 25m x 6mm high pressure nylon tubing
- 10 x 90 deg M6 x 6mm tube comp fittings
- 5 x 90 deg M8 x 6mm tube comp fittings
- 10 x 90 deg 1/8BSP x 6mm tube comp fittings
- 10 x Straight M6 x 6mm tube comp fittings
- 5 x Straight M8 x 6mm tube comp fittings
- 10 x Straight 1/8BSP 6mm tube comp fittings
- 5 x Straight 1/4BSP x 6mm tube comp fittings
- 5 x 6mm x 6mm straight comp fitting connectors
- 10 x Straight M6 x 6mm tube push in fittings
- 5 x Straight M8 x 6mm tube push in fittings
- 10 x Straight 1/8BSP x 6mm tube push in fittings
- 10 x 90 deg swivel M6 x 6mm tube push in fittings
- 5 x 90 deg swivel M8 x 6mm tube push in fittings
- 10 x 90 deg swivel 1/8BSP x 6mm tube push in fittings
- 5 x 6mm x 6mm Straight push in fitting connectors
- 3 x Straight 1/4BSP M x 1/8BSP adaptors
- 5 x 45 deg 1/8BSPM x 1/8BSPF adaptors
- 5 x 90 deg 1/8BSPM x 1/8BSPF adaptor
- 5 x 1/4BSPM x 1/8BSPF reducer
- 10 x compression nuts
- 10 x olives
- 20 x 1/BSP Straight grease nipples
- 1 x Bulkhead
- 1 x thread tape
- 1 x tube cutter

8.6mm 7/16 JIC Grab Kit



40-GRAB5

7/16 JIC 8.6MM GREASE LINE KIT INCLUDES

- 1 x carry assortment case
- 10 x 90 deg 7/16 JIC reusable hose end
- 10 x Straight 7/16 JIC reusable hose end
- 3 x 45 deg 7/16 JIC Reusable hose end
- 6 x 7/16" Male x 1/8BSP male nipple straight
- 6 x 7/16" male x 8mm male nipple straight
- 6 x 7/16" male x 6mm male nipple straight
- 5 x 7/16" male x 7/16" male nipple straight joiner
- 23 x Screw Sleeves

TYPICAL INSTALLATIONS

Miller Nitro Chassis And Boom Sprayer

- 6mm nylon tube system with push-in fitting
- Improved lubrication efficiency and made it easier for owner



Miller Nitro



Right hand grease anchor block bank

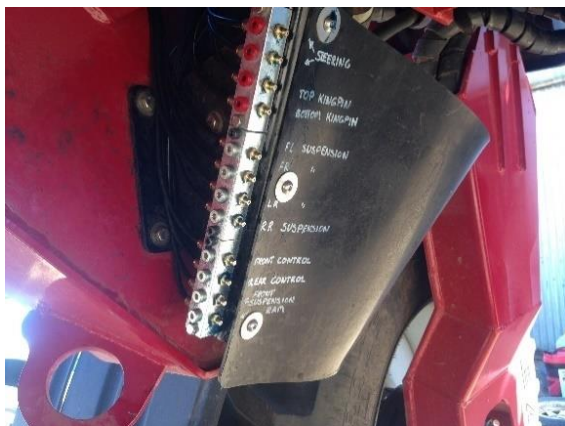

Left Hand grease anchor block bank



Suspension grease lines



Axel grease anchor block bank



Steering and King Pin

TYPICAL INSTALLATIONS

Mack Truck

- 8.6mm remote grease tube with reusable swivel fittings.
- Efficiency and safety improved



Mack Truck



5 x 5 grease anchor blocks



S-Cam grease lines



Turn table grease lines

Wharf Conveyor System

- 6mm stainless remote grease tube with compression fitting.
- Installed due to new safety guarding erected, making it impossible to grease.



2 outlet grease anchor block



Bearing and seal grease lines

CONTACT



Fat Adder Remote Grease Lines & Auto Lube Fittings

Manufactured by
Lube Control Pty Ltd
5/53 Norfolk Rd
Marion
South Australia 5043

p: 08 8298 5563
e: sales@lubecontrol.com.au
www.remotegreaselines.com



Distributed by:

